

FARUM BADMINTON

Resultatprogram

for

Klubmesterskaberne

Seniorer

2001 / 2002

Herresingle Mesterrække

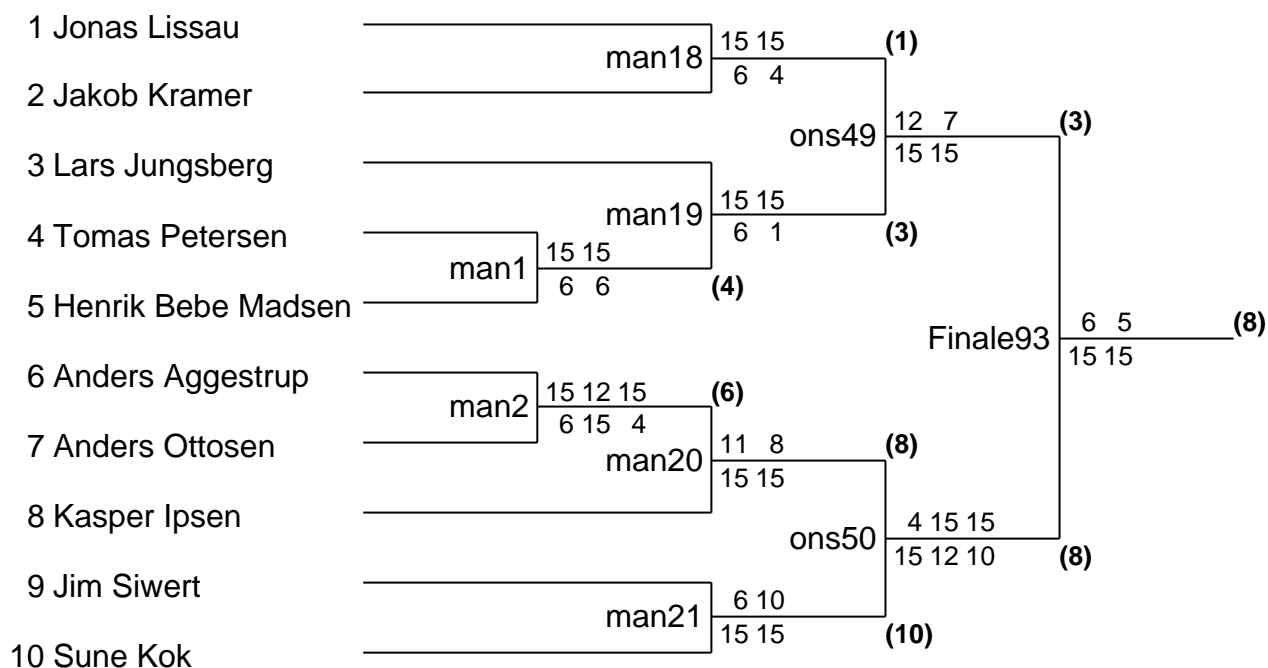

Herredouble Mesterrække

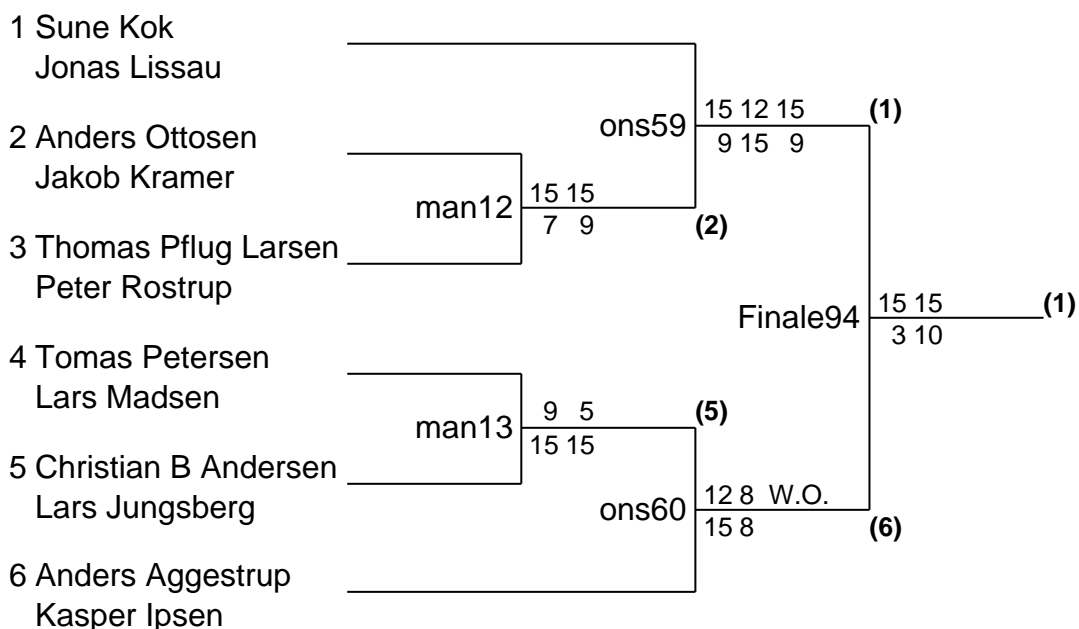

Damesingle Mesterrække Pulje 1

1 Rikke H Larsen	3.	1-2 Kamp man8 3/11 3/11	(2)
		1-3 Kamp man17 1/11 0/11	(3)
2 Trine Christiansen	2.	2-3 Kamp ons53 8/11 2/11	(3)
3 Tine Enghave	1.		

Finale spilles mellem nr. 1 og 2 i puljen

2 Trine Christiansen	1	3	
		-----	(3)
3 Tine Enghave	11	11	

Damedouble Mesterrække Pulje 1

1 Rikke H Larsen	3.	1-2 Kamp man16 5/15 7/15	(2)
Oline Westerdahl		1-3 Kamp man27 2/15 9/15	(3)
		2-3 Kamp ons61 15/8 10/15 11/15	(3)
2 Connie F Larsen	2.		
Tine Enghave			
3 Trine Christiansen	1.		
Maja Enghave			

Finale spilles mellem nr. 1 og 2 i puljen

2 Connie F Larsen			
Tine Enghave	15	15	15
		-----	(2)
3 Trine Christiansen	10	17	7
Maja Enghave			

Mixeddouble Mesterrække

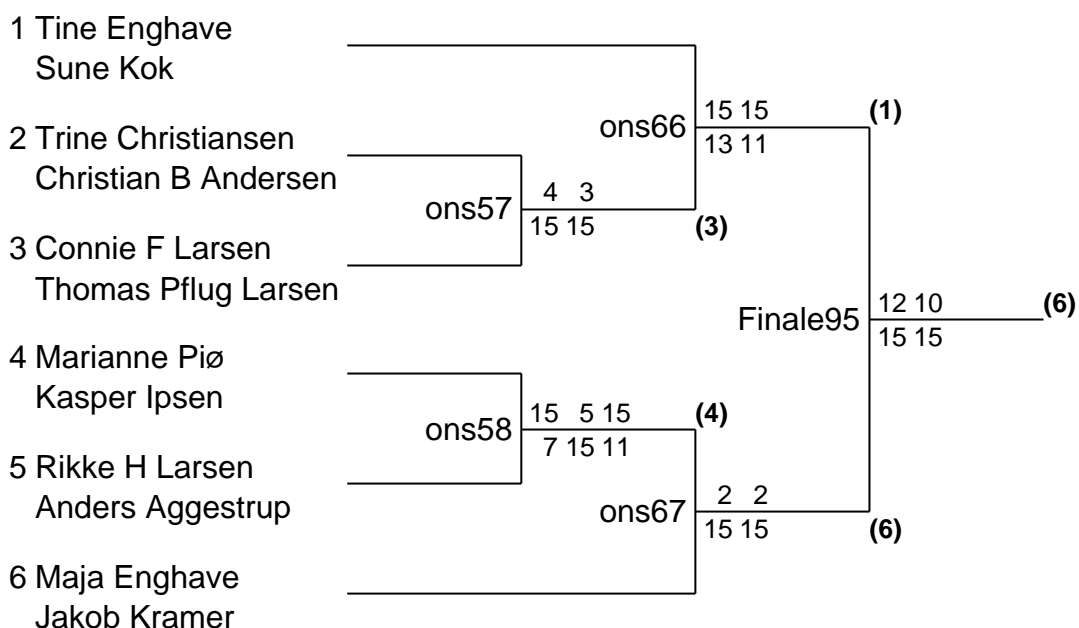

Herresingle Senior-A

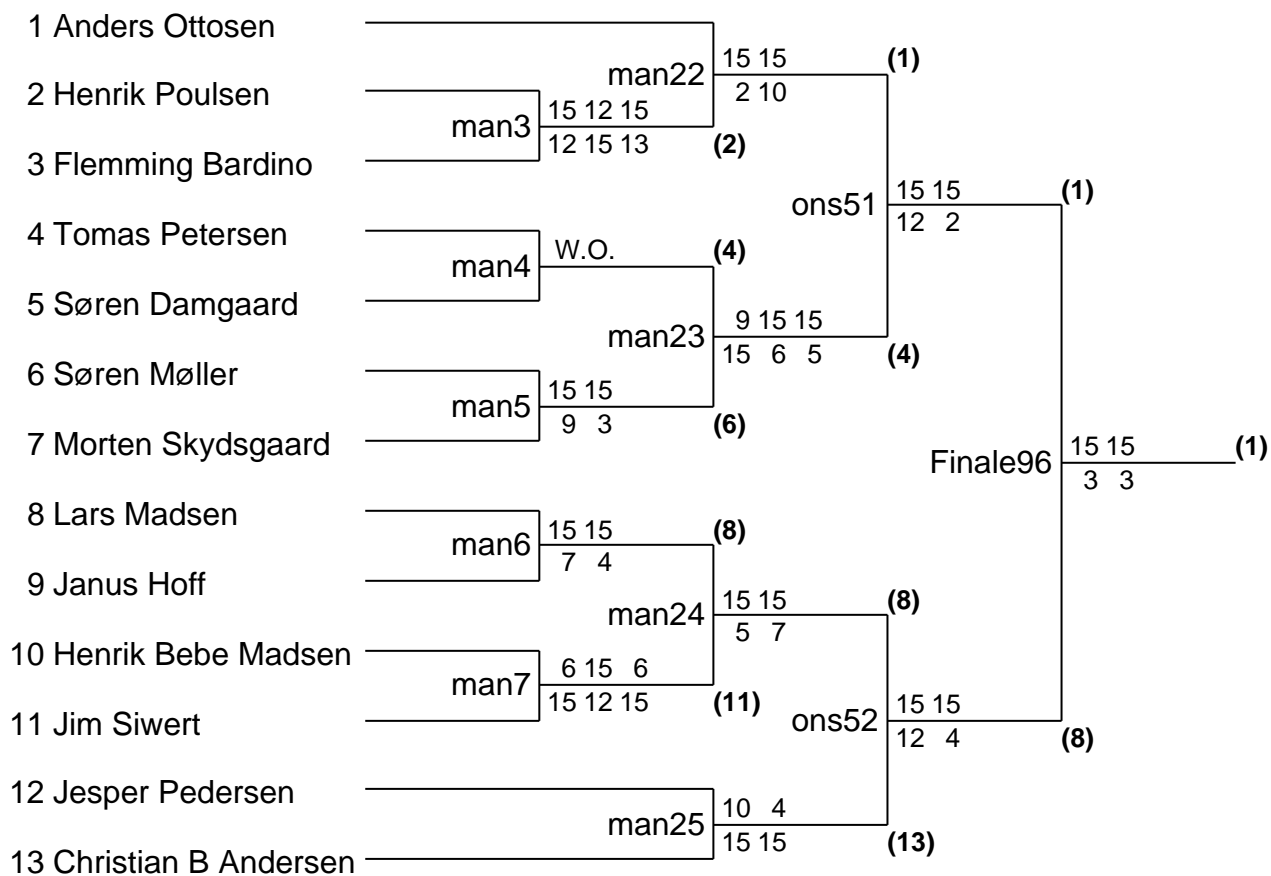

Herredouble Senior-A

1 Lars Madsen Tomas Petersen					
2 Henrik Bebe Madsen Jim Siwert	man14	15 15 1 13	ons62	15 7 W.O. 7 15	(2)
3 Henrik Poulsen Jesper Pedersen					(2)
4 Søren Møller Janus Hoff	man15	11 11 15 15			(5)
5 Flemming Bardino Morten Skydsgaard			ons63	8 7 15 15	(6)
6 Thomas Pflug Larsen Peter Rostrup					
				Finale98	12 10 15 15
					(6)

Damesingle Senior-A

1 Rikke H Larsen					
2 Hanne Bebe Madsen	man9	8 11 9 11 6 11	ons55	11 11 6 2	(1)
3 Louise Borregaard					(3)
4 Kathrine Hyllegaard	man10	1 1 11 11			(5)
5 Mie Andersen			ons56	9 11 11 11 2 2	(5)
6 Christina Schmidt					
				Finale97	11 11 1 4
					(1)

Damedouble Senior-A Pulje 1

1 Kathrine Hyllegaard Louise Borregaard	3.	1-2 Kamp man11 3/15 2/15 1-3 Kamp man26 2/15 8/15 2-3 Kamp ons54 9/15 9/15	(2) (3) (3)
2 Mie Andersen Marianne Piø	2.		
3 Christina Schmidt Lene Christensen	1.		

Finale spilles mellem nr. 1 og 2 i puljen

2 Mie Andersen Marianne Piø	12 8	
	-----	(3)
3 Christina Schmidt Lene Christensen	15 15	

Mixeddouble Senior-A

1 Christina Schmidt Anders Ottosen	ons64	15 5 12 2 15 15	(2)	
2 Hanne Bebe Madsen Henrik Bebe Madsen				
3 Mie Andersen Jim Siwert	ons65	12 12 15 15	(4)	
4 Lene Christensen Lars Madsen				
		Finale99	15 15 10 11	(2)

Herresingle Senior-B

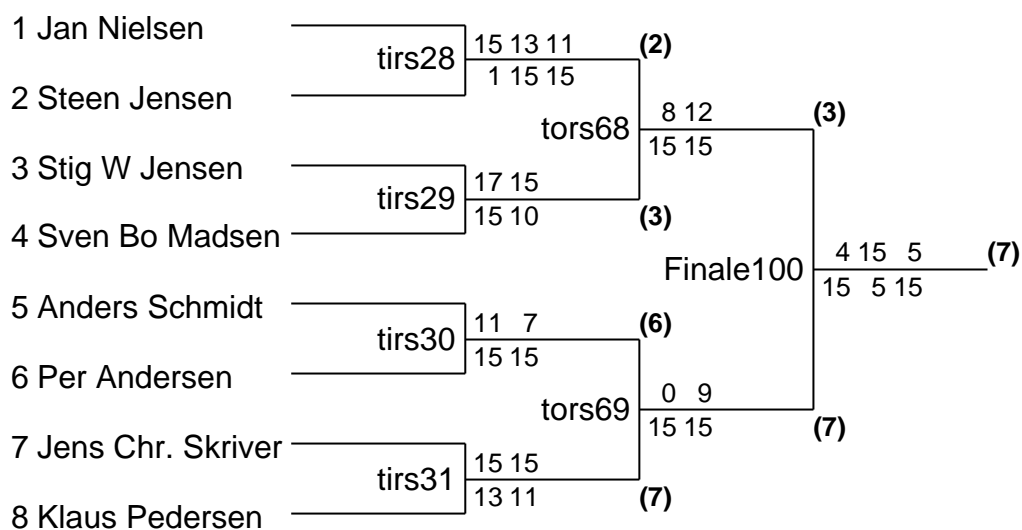

Herredouble Senior-B

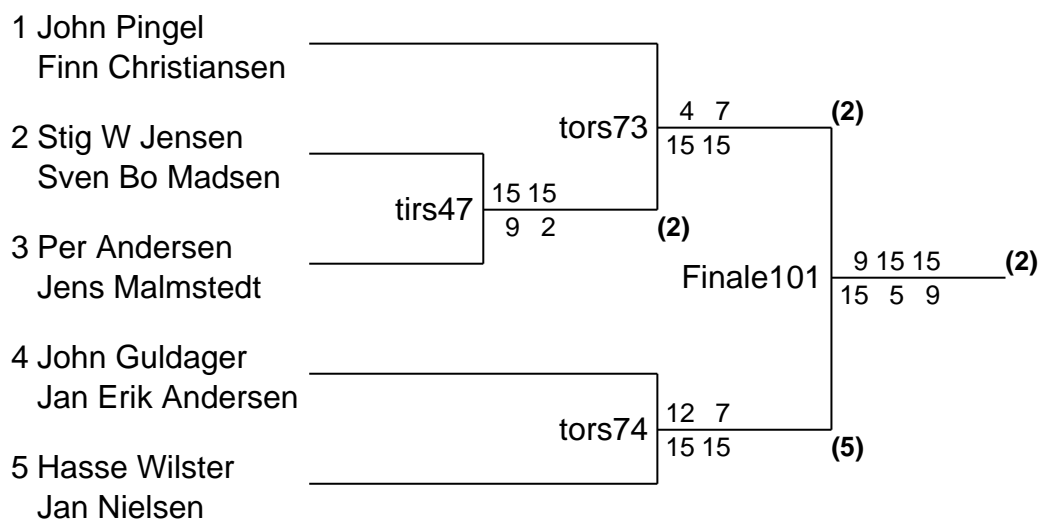

Damedouble Senior-B Pulje 1

1 May-Britt Kruse Lis Jones	2.	1-2 Kamp tirs34 17/14 17/16 1-3 Kamp tirs44 6/15 8/15 2-3 Kamp tors79 5/15 13/15	(1) (3) (3)
2 Susanne Bebe Kirsten Enghave	3.		
3 Susan Mathiasen Birgit Thier	1.		

Finale spilles mellem nr. 1 og 2 i puljen

1 May-Britt Kruse Lis Jones	10 15 15	
	-----	(1)
3 Susan Mathiasen Birgit Thier	15 8 13	

Mixeddouble Senior-B

1 Susan Mathiasen Kim Mathiasen	tors85	15 15 10 7	(1)	
2 May Schou Andersen Per Andersen				
3 May-Britt Kruse Hasse Wilster	tors86	15 15 8 10	(3)	
4 Pia Schnedler-Meyer Finn Christiansen				
		Finale102	15 16 15 13 17 3	(1)

Herredouble Senior-C Pulje 1

1 Martin Seindal	2.	1-2 Kamp tirs35	15/10 15/3	(1)
Michael Sørensen		1-3 Kamp tirs45	13/15 12/15	(3)
		2-3 Kamp tors80	7/15 3/15	(3)
2 Søren Aggestrup	3.			
Henning Larsen				
3 Steen Jensen	1.			
Lars Madsen				

Finale spilles mellem nr. 1 og 2 i puljen

1 Martin Seindal		
Michael Sørensen		
	-----	(3)
3 Steen Jensen	W.O.	
Lars Madsen		

Damedouble Senior-C

1 May Schou Andersen	}	tirs36	15 15	(1)
Lisbeth Hoffmann				
2 Margot Schmidt	}	tirs37	15 15	(3)
Gitte Grocott				
3 Birgit Piø				
Berit Engberg				
4 Anne Margrethe Aggestrup				
Anita Hjorth Larsen				
		Finale103	15 15	(1)
			5 9	

Mixeddouble Senior-C

1 Anne Margrethe Aggestrup Søren Aggestrup	tors87	9 4 15 15	(2)
2 Lisbeth Hoffmann-Petersen Klaus Hoffmann-Petersen			
3 Anita Hjorth Larsen Jesper Piø	tors88	15 8 15 10 15 12	(3)
4 Birgit Piø Henning Larsen			
Finale104			15 15 (2) 5 6

Herresingle Veteran40-A

1 Henrik Jacobsen	tirs39	15 15 1 8	(1)
2 Klaus Pedersen			
3 Anders Schmidt	tirs40	9 9 15 15	(5)
4 Per Andersen			
5 Lars Balch	tirs32	15 15 13 4 17 15	(5)
6 Stig W Jensen	tirs41	15 15 8 8	(6)
7 Kim Mathiasen			
8 Torben Theter	tirs42	7 7 15 15	(9)
9 Søren Damgaard			
tirs70			15 15 (1) 1 2
tirs71			2 0 W.O. 15 14 (6)
Finale105			15 15 (1) 1 6

Herredouble Veteran40-A

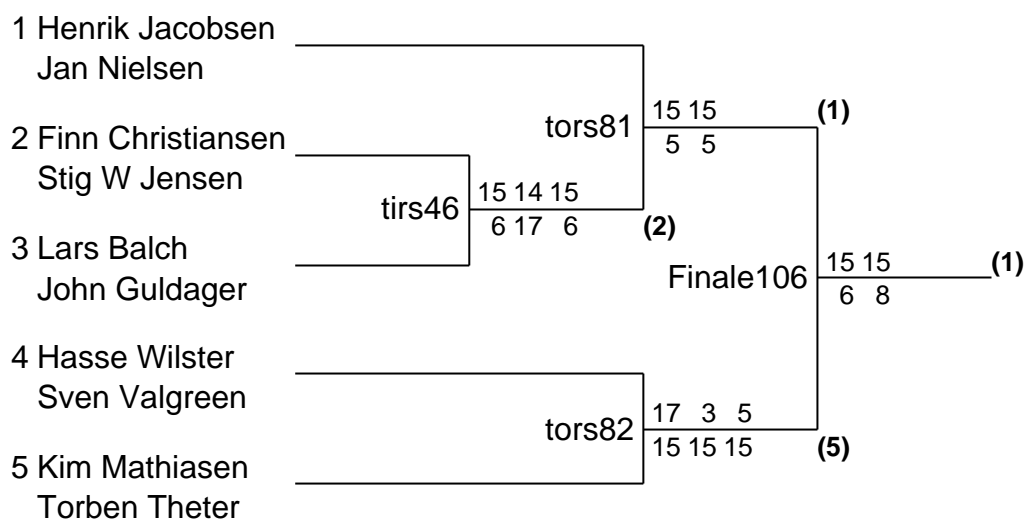

Damedouble Veteran40-A

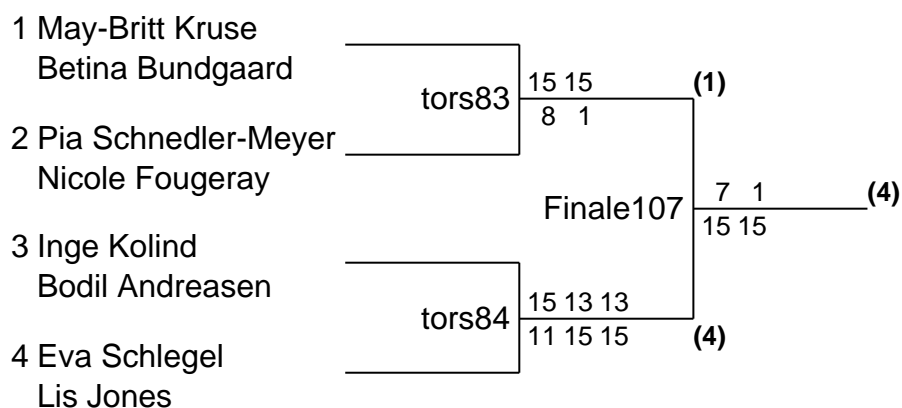

Mixeddouble Veteran40-A

1 May-Britt Kruse Søren Damgaard	tors75	15 15 2 2	(1)	
2 Margot Schmidt Anders Schmidt				tors91 15 14 W.O. (3)
3 Pia Schnedler-Meyer Lars Balch	tors76	15 9 15 9 15 6	(3)	
4 Betina Bundgaard Hasse Wilster				Finale108 6 9 (6) 15 15
5 Nicole Fougeray Jan Nielsen	tors77	3 2 15 15	(6)	
6 Eva Schlegel Torben Theter				tors92 15 15 (6) 10 8
7 Bodil Andreasen Finn Christiansen				

Herresingle Veteran40-B Pulje 1

1 Klaus Hoffmann-Petersen	2.	1-2 Kamp tirs33 5/15 7/15	(2)
		1-3 Kamp tirs43 15/5 15/5	(1)
2 Jens Chr. Skriver	1.	2-3 Kamp tors72 15/7 15/1	(2)
3 Stig Olsen	3.		

Finale spilles mellem nr. 1 og 2 i puljen

1 Klaus Hoffmann-Petersen	5 6	
	-----	(2)
2 Jens Chr. Skriver	15 15	

Herredouble Veteran40-B Pulje 1

1 Steen Jensen	1.	1-2 Kamp tirs38 15/4 15/3	(1)
Lars Madsen		1-3 Kamp tirs48 15/4 15/4	(1)
		2-3 Kamp tors78 15/10 15/6	(2)
2 Klaus Hoffmann-Petersen	2.		
Stig Olsen			
3 Søren Aggestrup	3.		
Jesper Piø			

Finale spilles mellem nr. 1 og 2 i puljen

1 Steen Jensen			
Lars Madsen	15 13 12		
	-----	(2)	
2 Klaus Hoffmann-Petersen	12 15 15		
Stig Olsen			

Herredouble Veteran50-A

1 Sven Bo Madsen	tors89	16 7	(2)
Sven Valgreen			
2 Finn Christiansen	Finale109	10 15 6	(3)
Jens Malmstedt			
3 Anders Schmidt			
Henning Beyer		15 12 15	

Damedouble Veteran50-A

1 Eva Schlegel	Finale110	2 2	(2)
Nicole Fougeray			
2 Bodil Andreasen		15 15	
Lis Jones			

Mixeddouble Veteran50-A

1 Eva Schlegel Finn Christiansen	tors90	15 15 7 17 8 15	(2)
2 Bodil Andreasen Henning Beyer		Finale111	15 15 9 4
3 Nicole Fougeray Sven Valgreen			(2)

Mesterrække

Anders Aggestrup (HD+MD+HS)
Anders Ottosen (HS+HD)
Christian B Andersen (HD+MD)
Connie F Larsen (DD+MD)
Henrik Bebe Madsen (HS)
Jakob Kramer (MD+HD+HS)
Jim Siwert (HS)
Jonas Lissau (HD+HS)
Kasper Ipsen (MD+HS+HD)
Lars Jungsberg (HD+HS)

Lars Madsen (HD)
Maja Enghave (DD+MD)
Marianne Piø (MD)
Oline Westerdahl (DD)
Peter Rostrup (HD)
Rikke H Larsen (MD+DS+DD)
Sune Kok (MD+HD+HS)
Thomas Pflug Larsen (HD+MD)
Tine Enghave (MD+DD+DS)
Tomas Petersen (HS+HD)
Trine Christiansen (DD+MD+DS)

Senior-A

Anders Ottosen (HS+MD)
Christian B Andersen (HS)
Christina Schmidt (DS+MD+DD)
Flemming Bardino (HS+HD)
Hanne Bebe Madsen (DS+MD)
Henrik Bebe Madsen (HD+HS+MD)
Henrik Poulsen (HD+HS)
Janus Hoff (HD+HS)
Jesper Pedersen (HD+HS)
Jim Siwert (HS+HD+MD)
Kathrine Hyllegaard (DD+DS)

Lars Madsen (HS+HD+MD)
Lene Christensen (DD+MD)
Louise Borregaard (DD+DS)
Marianne Piø (DD)
Mie Andersen (MD+DS+DD)
Morten Skydsgaard (HD+HS)
Peter Rostrup (HD)
Rikke H Larsen (DS)
Søren Damgaard (HS)
Søren Møller (HD+HS)
Thomas Pflug Larsen (HD)
Tomas Petersen (HD+HS)

Senior-B

Anders Schmidt (HS)
Birgit Thier (DD)
Finn Christiansen (MD+HD)
Hasse Wilster (MD+HD)
Jan Erik Andersen (HD)
Jan Nielsen (HD+HS)
Jens Chr. Skriver (HS)
Jens Malmstedt (HD)
John Guldager (HD)
John Pingel (HD)
Kim Mathiasen (MD)

Kirsten Enghave (DD)
Klaus Pedersen (HS)
Lis Jones (DD)
May Schou Andersen (MD)
May-Britt Kruse (DD+MD)
Per Andersen (HS+MD+HD)
Pia Schnedler-Meyer (MD)
Steen Jensen (HS)
Stig W Jensen (HS+HD)
Susan Mathiasen (MD+DD)
Susanne Bebe (DD)
Sven Bo Madsen (HD+HS)

Farum Badminton

Senior-C

Anita Hjorth Larsen (DD+MD)
Anne Margrethe Aggestrup (DD+MD)
Berit Engberg (DD)
Birgit Piø (MD+DD)
Gitte Grocott (DD)
Henning Larsen (MD+HD)
Jesper Piø (MD)
Klaus Hoffmann-Petersen (MD)

Lars Madsen (HD)
Lisbeth Hoffmann (DD)
Lisbeth Hoffmann-Petersen (MD)
Margot Schmidt (DD)
Martin Seindal (HD)
May Schou Andersen (DD)
Michael Sørensen (HD)
Steen Jensen (HD)
Søren Aggestrup (MD+HD)

Veteran40-A

Anders Schmidt (HS+MD)
Betina Bundgaard (MD+DD)
Bodil Andreasen (DD+MD)
Eva Schlegel (DD+MD)
Finn Christiansen (MD+HD)
Hasse Wilster (MD+HD)
Henrik Jacobsen (HS+HD)
Inge Kolind (DD)
Jan Nielsen (HD+MD)
John Guldager (HD)
Kim Mathiasen (HS+HD)

Klaus Pedersen (HS)
Lars Balch (MD+HS+HD)
Lis Jones (DD)
Margot Schmidt (MD)
May-Britt Kruse (DD+MD)
Nicole Fougeray (MD+DD)
Per Andersen (HS)
Pia Schnedler-Meyer (MD+DD)
Stig W Jensen (HD+HS)
Sven Valgreen (HD)
Søren Damgaard (MD+HS)
Torben Theter (HS+MD+HD)

Veteran40-B

Jens Chr. Skriver (HS)
Jesper Piø (HD)
Klaus Hoffmann-Petersen (HS+HD)

Lars Madsen (HD)
Steen Jensen (HD)
Stig Olsen (HD+HS)
Søren Aggestrup (HD)

Veteran50-A

Anders Schmidt (HD)
Bodil Andreasen (MD+DD)
Eva Schlegel (DD+MD)
Finn Christiansen (HD+MD)
Henning Beyer (HD+MD)

Jens Malmstedt (HD)
Lis Jones (DD)
Nicole Fougeray (DD+MD)
Sven Bo Madsen (HD)
Sven Valgreen (HD+MD)